

Series 97 stainless steel cylinders

Single- and double-acting, cushioned, magnetic.
 ø 32, 40, 50, 63 mm



- » Clean design
- » Stainless steel AISI 304
- » Adjustable endstroke cushioning

Series 97 stainless steel cylinders can be used in critical applications where a high level of corrosion resistance is required (for example: off-shore, naval, food industries).

These cylinders are normally equipped with end-stroke cushioning which can be adjusted through a screw on the end block.
 In order to quieten the impact of the piston on the end block, these cylinders are also equipped with mechanical cushioning.

GENERAL DATA

Type of construction	the end blocks are screwed to the tube with an intermediate Teflon ring
Operation	single-acting and double-acting
Materials	end blocks, tube, rod in stainless steel AISI 304 rod seals in PU, piston seals in NBR plastic guiding element, NSF H1-certified lubricant
Type of mounting	threaded front and rear locking ring pins on front cap ends rear male hinge articulated rear male hinge rear female hinge
Stroke min-max	25 ÷ 800 mm
Operating temperature	0°C ÷ 80°C (with dry air - 20°C)
Operating pressure	1 ÷ 10 bar
Speed	10 ÷ 1000 mm/sec (without load)
Fluid	Filtered air, without lubrication. If lubricated air is used, it is recommended to use oil ISOVG32. Once applied the lubrication should never be interrupted.

STANDARD STROKES FOR CYLINDERS SERIES 97

- = Single-acting
- * = Double-acting

STANDARD STROKES		25	50	75	80	100	125	150	160	200	250	300	320	400	500
Ø															
32	**	**	*	*	*	*	*	*	*	*	*	*	*	*	*
40	**	**	*	*	*	*	*	*	*	*	*	*	*	*	*
50	**	**	*	*	*	*	*	*	*	*	*	*	*	*	*
63	**	**	*	*	*	*	*	*	*	*	*	*	*	*	*

CODING EXAMPLE

97	M	2	A	050	A	0200	
-----------	----------	----------	----------	------------	----------	-------------	--

97	SERIES						
M	VERSIONS: M = rear male hinge S = articulated rear male hinge F = rear female hinge T = front and rear threaded end blocks A = front end block with pin						
2	OPERATION: 1 = single-acting, front spring 2 = double-acting, front and rear cushions 6 = double-acting, through-rod, front and rear cushions (T and A versions only)				PNEUMATIC SYMBOLS: CS06 CD09 CD13		
A	MATERIALS: A = stainless steel AISI 304 - PU seals V = stainless steel AISI 304 - FKM seals (150°C)						
050	BORE: 032 = 32 mm - 040 = 40 mm - 050 = 50 mm - 063 = 63 mm						
A	TYPE OF DESIGN: A = standard (locking ring for end cap V + lock nut for rod U)						
0200	STROKE (see the table)						
	= standard V = rod seal in FKM						

PNEUMATIC SYMBOLS

The pneumatic symbols which have been indicated in the CODING EXAMPLE are shown below.

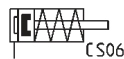
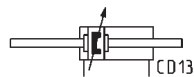
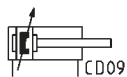

ACCESSORIES FOR STAINLESS STEEL CYLINDERS SERIES 97

Foot mount Mod. B

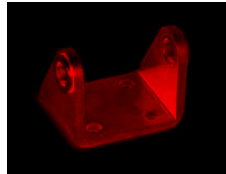

Trunnion bracket Mod. I

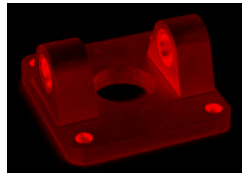

Rear female trunnion bracket Mod. C-H



Tight rear female tr. bracket Mod. CR



Male tr. bracket with swivel ball joint Mod. R



90° male tr. bracket + sw. ball joint Mod. ZCR



Rod fork end Mod. G-90

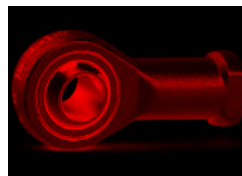

Swivel ball joint Mod. GA-90



Piston rod lock nut Mod. U-90

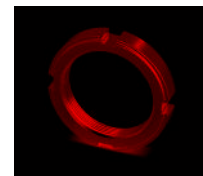

Nose nut Mod. V-97

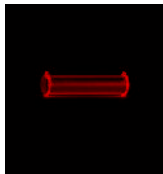

Clevis pin Mod. S-90



Anti-rotation clevis pin Mod. SR-90



All accessories are supplied separately, except for piston rod lock nut Mod. U and nose nut Mod. V.

Cylinders Series 97, Mod. T

With threaded front and rear end blocks

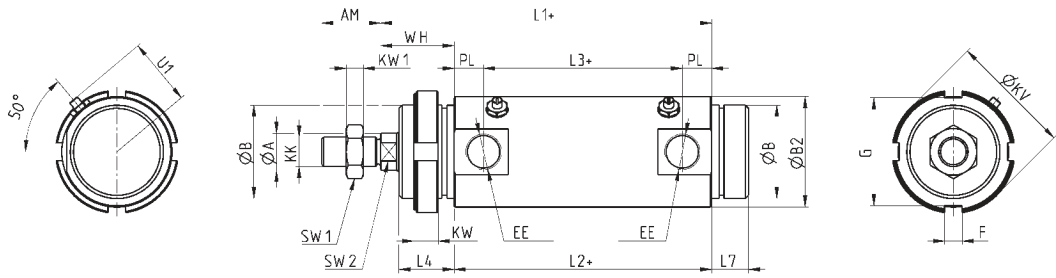

+ = add the stroke

DIMENSIONS

Ø	ØA	AM	ØB	ØB2	EE	F	G	KK	PL	SW1	KW1	SW2	U1	WH	L1+	L2+	L3+	L4	L7	KW	ØKV
32	12	22	M30x1.5	36	G1/8	5	38	M10x1.25	9	17	6	10	23	26	120	94	76	19.5	15	7	42
40	16	24	M38x1.5	45	G1/4	6	50	M12x1.25	12	19	7	13	27	30	135	105	81	22.5	15	8	55
50	20	32	M45x1.5	55	G1/4	6	53	M16x1.5	12	24	8	17	33	37	143	106	82	28	18	10	60
63	20	32	M45x1.5	68	G3/8	6	53	M16x1.5	13	24	8	17	40	37	158	121	95	28	18	10	60

Cylinders Series 97, Mod. T - through-rod

With threaded end blocks

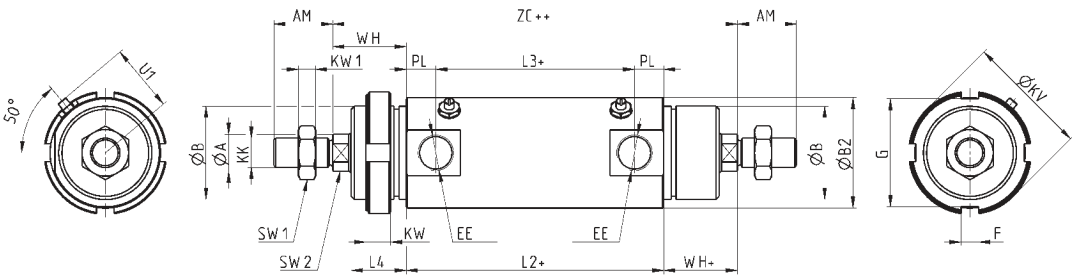

+ = add the stroke once
 ++ = add the stroke twice

DIMENSIONS

Ø	ØA	AM	ØB	ØB2	EE	F	G	KK	PL	SW1	KW1	SW2	U1	WH+	L2+	L3+	L4	KW	ØKV	ZC++
32	12	22	M30x1.5	36	G1/8	5	38	M10x1.25	9	17	6	10	23	26	94	76	19.5	7	42	146
40	16	24	M38x1.5	45	G1/4	6	50	M12x1.25	12	19	7	13	27	30	105	81	22.5	8	55	165
50	20	32	M45x1.5	55	G1/4	6	53	M16x1.5	12	24	8	17	33	37	106	82	28	10	60	180
63	20	32	M45x1.5	68	G3/8	6	53	M16x1.5	13	24	8	17	40	37	121	95	28	10	60	195

Cylinders Series 97, Mod. M

With rear male trunnion bracket

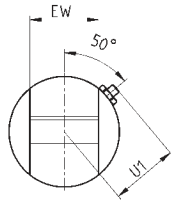

+ = add the stroke

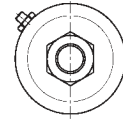
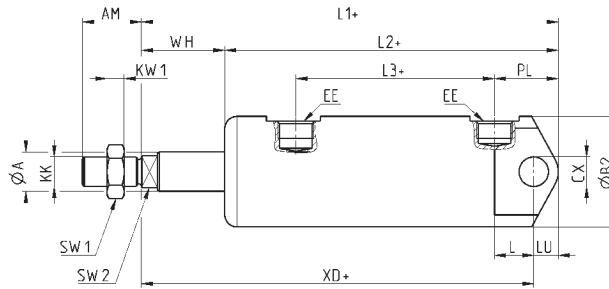
DIMENSIONS

Ø	ØA	AM	ØB2	CX	EE	EW	KK	PL	SW1	KW1	SW2	U1	WH	L1+	L2+	L3+	L	LU	XD+
32	12	22	36	10	G1/8	26	M10x1.25	23	17	6	10	23	26	151	125	76	13	9	142
40	16	24	45	12	G1/4	28	M12x1.25	26	19	7	13	27	34	170	136	81	16	10	160
50	20	32	55	12	G1/4	32	M16x1.5	32	24	8	17	33	37	182	145	82	16.5	12	170
63	20	32	68	16	G3/8	40	M16x1.5	29.5	24	8	17	40	50	202	152	95	21	12	190

Cylinders Series 97, Mod. S

With articulated rear male trunnion bracket

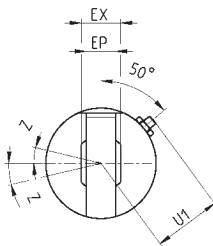

+ = add the stroke

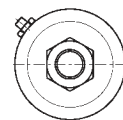
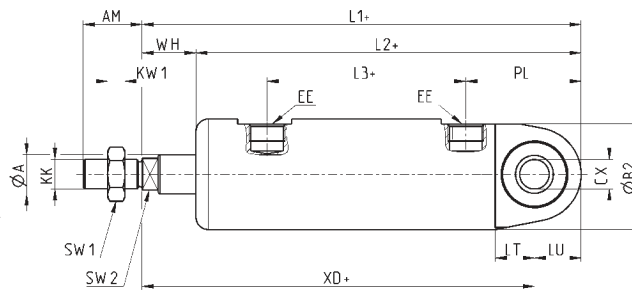
DIMENSIONS

Ø	ØA	AM	ØB2	CX	EE	EP	EX	KK	PL	SW1	KW1	SW2	U1	WH	L1+	L2+	L3+	LT	LU	XD+	Z
32	12	22	36	10	G1/8	10.5	14	M10x1.25	37	17	6	10	23	18	157	139	76	13	15	142	13
40	16	24	45	12	G1/4	12	16	M12x1.25	47	19	7	13	27	22	179	157	81	16	19	160	13
50	20	32	55	16	G1/4	15	21	M16x1.5	49	24	8	17	33	28.5	190.5	162	82	16.5	20.5	170	15
63	20	32	68	16	G3/8	15	21	M16x1.5	60	24	8	17	40	31.5	214	182.5	95	21	24	190	15

Cylinders Series 97, Mod. F

With rear female trunnion bracket



+ = add the stroke

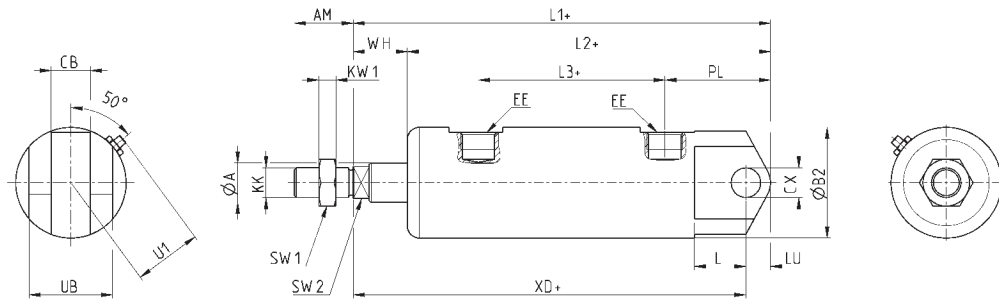

DIMENSIONS

Ø	ØA	AM	ØB2	CB	CX	EE	KK	PL	SW1	KW1	SW2	U1	WH	L1+	L2+	L3+	L	LU	XD+	UB
32	12	22	36	14	10	G1/8	M10x1.25	31	17	6	10	23	18	151	133	76	13	9	142	34
40	16	24	45	16	12	G1/4	M12x1.25	38	19	7	13	27	22	170	148	81	16	10	160	40
50	20	32	55	21	16	G1/4	M16x1.5	45.5	24	8	17	33	28.5	182	153.5	82	21	12	170	45
63	20	32	68	21	16	G3/8	M16x1.5	48	24	8	17	40	31.5	202	170.5	95	21	12	190	51

Cylinders Series 97, Mod. A

With front end block with pins



+ = add the stroke

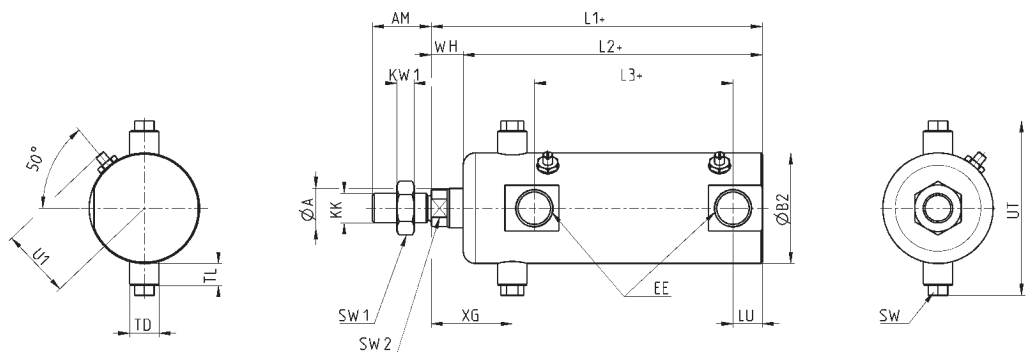

DIMENSIONS

Ø	ØA	AM	ØB2	EE	KK	SW	SW1	KW1	SW2	U1	WH	L1+	L2+	L3+	LU	XG	TD	TL	UT
32	12	22	36	G1/8	M10x1.25	8	17	6	10	23	9	120	111	76	9	27	10	7	58
40	16	24	45	G1/4	M12x1.25	8	19	7	13	27	13	135	122	81	12	33	12	9	71
50	20	32	55	G1/4	M16x1.5	8	24	8	17	33	18	143	125	82	12	40	14	9	81
63	20	32	68	G3/8	M16x1.5	12	24	8	17	40	22.5	158	135.5	95	13	45	16	12	104

Foot mount Mod. B

Material: stainless steel 304

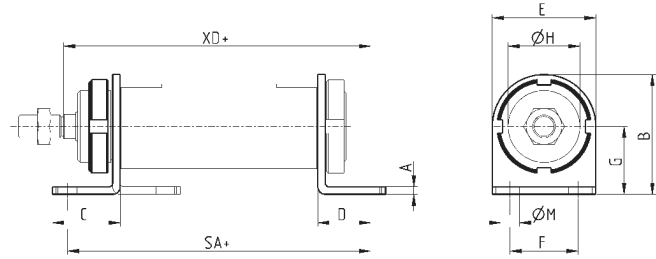
 Supplied with:
 1x nut
 2x single feet

+ = add the stroke

DIMENSIONS

Mod.	Ø	A	B	C	D	E	SA+	F	G	ØH	ØM	XD+
B-97-32	32	4	53	35	24	42	142	32	32	30	7	142
B-97-40	40	4	63.5	36	28	55	161	36	36	38	10	160
B-97-50	50	5	77.5	47	32	65	170	45	45	45	10	170
B-97-63	63	5	82.5	45	32	65	185	50	50	45	10	190

Trunnion bracket Mod. I

Material: stainless steel 304

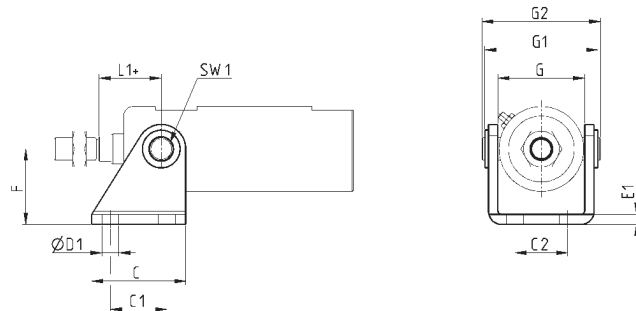
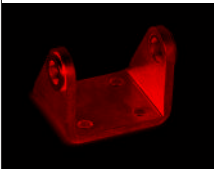
 Supplied with:
 1x female trunnion
 2x cartridges

+ = add the stroke

DIMENSIONS

Mod.	Ø	C	C1	C2	ØD1	E1	F	G	G1	G2	L1+	SW1
I-97-32	32	40	24	20	7	4	35	38	50	58	27	8
I-97-40	40	50	30	28	9	5	40	46	60	71	33	8
I-97-50	50	54	34	36	9	6	45	57	74	81	40	8
I-97-63	63	65	35	43	9	6	50	70	88	104	45	12

Rear female trunnion bracket Mod. C-H

Material: stainless steel 316

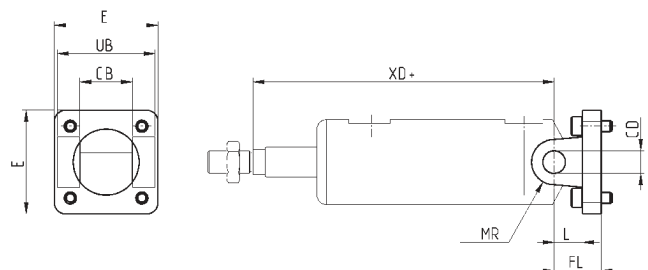
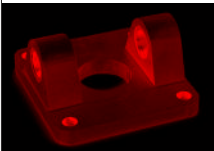
 Supplied with:
 1x female trunnion bracket
 4x screws

+ = add the stroke

DIMENSIONS

Mod.	Ø	CB	CD	E	FL	L	MR	UB	XD+
C-H-90-32	32	26	10	45	22	12	10	45	142
C-H-90-40	40	28	12	55	25	15	12	52	160
C-H-90-50	50	32	12	65	27	17	12	60	170
C-H-90-63	63	40	16	75	32	20	16	70	190

Tight rear female trunnion bracket Mod. CR

Material: stainless steel 316

Supplied with:
1x female trunnion bracket
4x screws

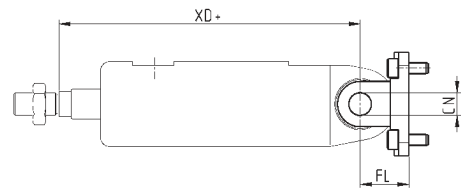
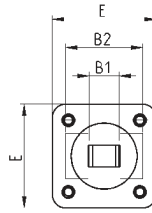

+ = add the stroke

DIMENSIONS							
Mod.	∅	B1	B2	E	CN	FL	XD+
CR-90-32	32	14	34	45	10	22	142
CR-90-40	40	16	40	55	12	25	160
CR-90-50	50	21	45	65	16	27	170
CR-90-63	63	21	51	75	16	32	190

Male trunnion bracket with swivel ball joint Mod. R

Material: stainless steel 316

Supplied with:
1x male trunnion bracket
4x screws

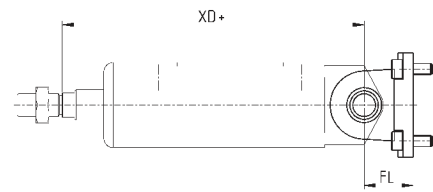
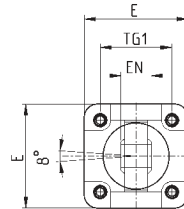

+ = add the stroke

DIMENSIONS							
Mod.	∅	E	EN	FL	TG1	XD+	
R-90-32	32	45	14	22	32.5	142	
R-90-40	40	55	16	25	38	160	
R-90-50	50	65	21	27	46.5	170	
R-90-63	63	75	21	32	56.5	190	

90° male trunnion bracket with swivel ball joint Mod. ZCR

Material: stainless steel 316

Supplied with:
1x male trunnion bracket
4x screws

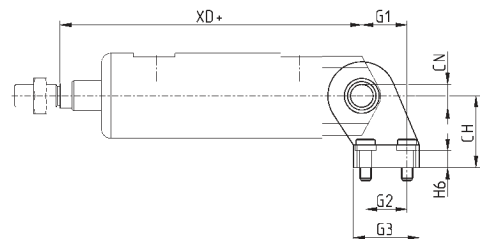
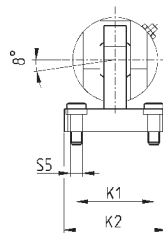

+ = add the stroke

DIMENSIONS											
Mod.	∅	CH	CN	G1	G2	G3	H6	K1	K2	S5	XD+
ZCR-90-32	32	32	10	21	18	31	10	38	51	6.6	142
ZCR-90-40	40	36	12	24	22	35	10	41	54	6.6	160
ZCR-90-50	50	45	16	33	30	45	12	50	65	9	170
ZCR-90-63	63	50	16	37	35	50	12	52	67	14	190

Rod fork end Mod. G-90

ISO 8140

Material: stainless steel 303

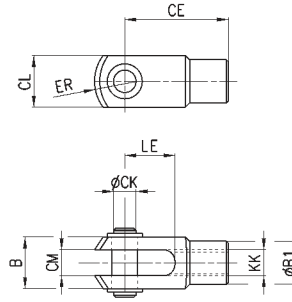
DIMENSIONS

Mod.	Ø	ØCK	LE	CM	CL	ER	CE	KK	B	ØB1
G-90-25-32	32	10	20	10	20	12	40	M10x1.25	26	18
G-90-40	40	12	24	12	24	14	48	M12x1.25	31	20
G-90-50-63	50-63	16	32	16	32	19	64	M16x1.5	39	26

Swivel ball joint Mod. GA-90

ISO 8139

Materials:

- stainless steel 304 bracket
- stainless steel 420 spherical ring
- sintered bronze bushing

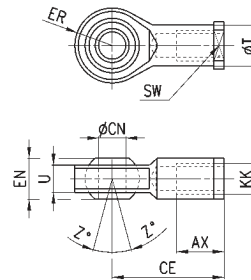

DIMENSIONS

Mod.	Ø	ØCN	U	EN	ER	AX	CE	KK	ØT	Z	SW
GA-90-32	32	10	10.5	14	14	20	43	M10x1.25	15	6.5	17
GA-90-40	40	12	12	16	16	22	50	M12x1.25	17.5	6.5	19
GA-90-50-63	50-63	16	15	21	21	28	64	M16x1.5	22	7.5	22

Piston rod lock nut Mod. U-90

ISO 4035

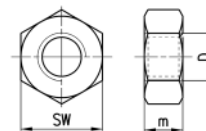
Material: stainless steel 304

DIMENSIONS

Mod.	Ø	D	m	SW
U-90-25-32	32	M10x1.25	6	17
U-90-40	40	M12x1.25	7	19
U-90-63	50-63	M16x1.5	8	24

Nose nut Mod. V-97

Material: stainless steel 304

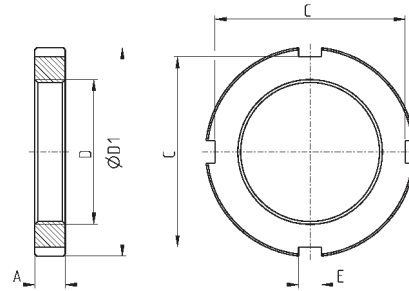
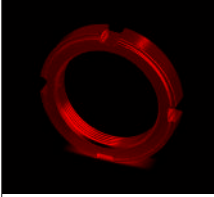

DIMENSIONS

Mod.	Ø	A	D	ØD1	E	C
V-97-32	32	7	M30x1.5	42	5	38
V-97-40	40	8	M38x1.5	55	6	50
V-97-50-63	50-63	10	M45x1.5	60	6	53

Clevis pin Mod. S-90

Supplied with:
1x clevis pin in stainless steel 303
2x seeger in steel

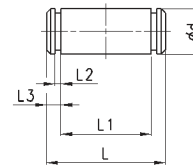
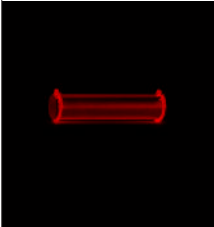

DIMENSIONS

Mod.	Ø	Ød	L	L1	L2	L3
S-90-32	32	10	53	46	1.1	3
S-90-40	40	12	60	53	1.1	3
S-90-50	50	12	68	61	1.1	3
S-90-63	63	16	78	71	1.1	3

Antirotating clevis pin Mod. SR-90

Supplied with:
1x antirotating clevis pin
in stainless steel 316
1x seeger in steel

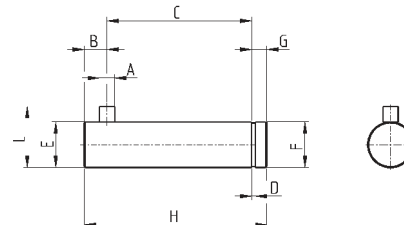

DIMENSIONS

Mod.	Ø	A	B	C	D	E	F	G	H	L
SR-90-32	32	3	4.5	32.5	1.1	10	9.6	4	41	14
SR-90-40	40	4	6	38	1.1	12	11.5	4	48	16
SR-90-50	50	4	6	43	1.1	16	15.2	5	54	20
SR-90-63	63	4	6	49	1.1	16	15.2	5	60	20